

A Miniature Relay with 1-pole 5 A Switching Capability and 10 kV Impulse Withstand Voltage

- ROHS compliant.
- Highly efficient magnetic circuit for high sensitivity (200 mW).
- Compact, slim, yet provides 10 kV impulse withstand voltage (between coil and contacts).
- Standard model conforms to UL, CSA and EN standards.
- Tracking resistance: CTI>250

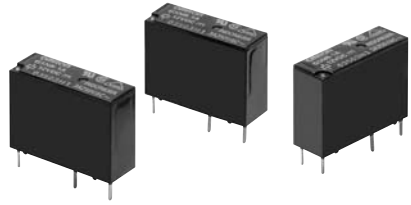

Ordering Information

Classification	Contact form	Enclosure ratings	Model
Standard	SPST-NO	Flux protection	G5NB-1A

Note: When ordering, add the rated coil voltage to the model number.

Example: G5NB-1A-E 12 VDC

Rated coil voltage

Model Number Legend

G5NB-□□-E □ VDC

1 2 3

1. Number of Poles

1: 1 pole

2. Contact Form

A: SPST-NO

3. Rated Coil Voltage

5, 12, 18, 24 VDC

Application Examples

Water heaters, refrigerators, air conditioners, and small electric appliances

Specifications

■ Coil Ratings

Rated voltage	5 VDC	12 VDC	18 VDC	24 VDC
Rated current	40.0 mA	16.7 mA	11.1 mA	8.3 mA
Coil resistance	125 Ω	720 Ω	1,620 Ω	2,880 Ω
Must operate voltage	75% max. of rated voltage			
Must release voltage	10% min. of rated voltage			
Max. voltage	170% of rated voltage (at 23°C)			
Power consumption	Approx. 200 mW			

Note: The rated current and coil resistance are measured at a coil temperature of 23°C with a tolerance of ±10%.
The operating characteristics are measured at a coil temperature of 23°C.
The “Max. voltage” is the maximum voltage that can be applied to the relay coil.

■ Contact Ratings

Load	Resistive load ($\cos\phi = 1$)
Rated load	5 A at 250 VAC, 3 A at 30 VDC
Contact material	AgNi
Max. switching voltage	250 VAC, 30 VDC
Max. switching current	5 A
Max. switching power	1250 VA, 90 W
Failure rate (reference value)	10 mA at 5 VDC

Note: P level: $\lambda_{60} = 0.1 \times 10^{-6}$ /operation (with an operating frequency of 120 operations/min)

■ Characteristics

Contact resistance (See note 2.)		100 mΩ max.
Operate time		10 ms max.
Release time		10 ms max.
Insulation resistance (See note 3.)		1,000 MΩ min. (at 500 VDC)
Dielectric strength		4,000 VAC, 50/60 Hz for 1 min between coil and contacts 750 VAC, 50/60 Hz for 1 min between contacts of same polarity
Impulse withstand voltage		10,000 V (1.2 x 50 ms) between coil and contacts
Insulation Distance	Creepage (Typ)	7.2 mm
	Clearance (Typ)	7.1 mm
Tracking Resistance (CTI)		250 V
Vibration resistance		Destruction: 10 to 55 to 10 Hz, 0.75-mm single amplitude (1.5-mm double amplitude) Malfunction: 10 to 55 to 10 Hz, 0.75-mm single amplitude (1.5-mm double amplitude)
Shock resistance		Destruction: 1,000 m/s ² Malfunction: 100 m/s ²
Endurance		Mechanical: 5,000,000 operations min. Electrical: 100,000 operations min (5 A at 250 VAC), 200,000 operations min. (3 A at 30 VDC)
Failure rate P level (reference value) (See note 4.)		5 VDC, 10 mA
Ambient temperature		Operating: -40°C to 85°C (with no icing or condensation)
Ambient humidity		Operating: 5% to 85%
Weight		Approx. 4 g

Note: 1. The data shown above are initial value.
2. Measurement conditions: 5 VDC, 1 A, voltage drop method.
3. Measurement conditions: Measured at the same points as the dielectric strength using a 500-VDC ohmmeter.
4. This value is for a switching frequency of 120 operations/minute.

■ Approved Standards UL508 (File No. 41515)

Coil ratings	Contact ratings
5 to 24 VDC	5 A, 30 VDC (resistive) 5 A, 125 VAC (resistive) 5 A, 250 VAC (general use)

CSA C22.2 (No. 0, No. 1, No. 14) (File No. LR31928)

Coil ratings	Contact ratings
5 to 24 VDC	5 A, 30 VDC (resistive) 5 A, 125 VAC (resistive) 5 A, 250 VAC (general use)

EN 61810-1 (VDE Reg No 137575)

Coil ratings	Contact ratings
5 to 24VDC	5 A, 30 VDC (resistive) 5 A, 250 VAC (general use)

■ Actual Load Life (Reference Values)

1. 120-VAC motor and lamp load (2.5-A surge and 0.5-A normal): 250,000 operations min.(at 23°C)
2. 160-VDC valve load (with varistor) (0.24-A): 250,000 operations min.(at 23°C)

Engineering Data

Maximum Switching Capacity

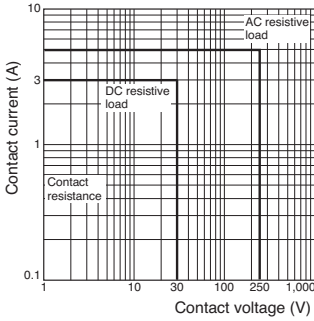

Endurance

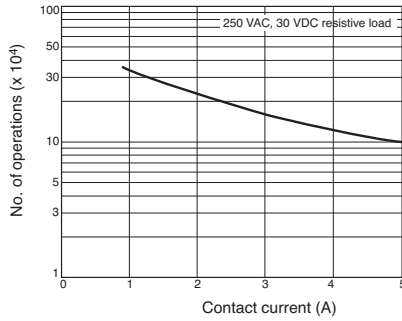

Ambient Temperature vs. Maximum Coil Voltage

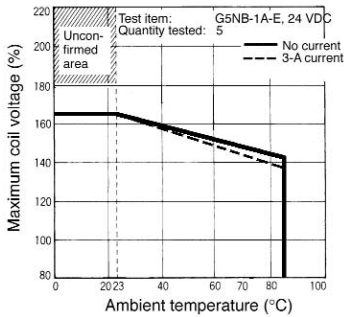

Malfunctioning Shock

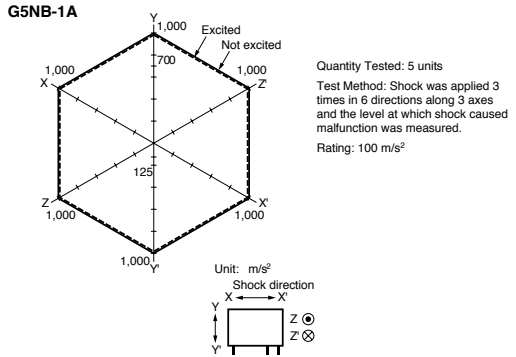

Dimensions

Note: All units are in millimetres unless otherwise indicated.

G5NB-1A-E

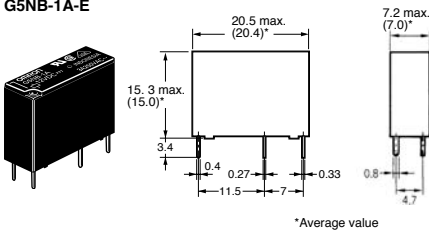

PCB Mounting Holes (Bottom View)

Tolerance: ±0.1 mm

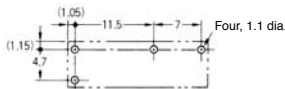

Terminal Arrangement/ Internal Connections (Bottom View)



(No coil polarity)

Precautions

■ Correct Use

HANDLING

The enclosure rating of the G5NB is for flux protection. Do not use immersion-cleaning.

ALL DIMENSIONS SHOWN ARE IN MILLIMETRES.

To convert millimetres into inches, multiply by 0.03937. To convert grams into ounces, multiply by 0.03527.